



distributed by

**HERITAGE
MILLWORK INC**

who is..... HERITAGE MILLWORK INC

Established in the Spring of 1997 in Ramsey, Minnesota, Heritage Millwork Inc has been servicing the Upper Midwest Market as a two-step distributor of mouldings, millwork, and doors, supplying more than 250 dealers in Minnesota, Wisconsin, South Dakota and Iowa.



Originally stocking only a few interior door designs in two wood species to now offering over twenty-five door designs in nine species, along with unlimited special-order options. Our large warehouse accommodates bigger volumes eliminating the need to wait for your products. In addition to a wide selection of interior doors, HMI also stocks over thirty moulding profiles in seven species including MDF, with special-order moulding profiles and a full offering of stair parts. Exterior entry door inventories also continue to evolve and expand, including products that promote striking curb appeal and home security as well as product performance including rot resistant materials.

In 2017 Heritage Millwork Inc opened Traditions Finishing Inc (TFI), a new pre-finishing facility, filling a growing desire amongst dealers to have products arrive at the job site finished and ready for installation. Together, HMI and TFI offer finishing solutions on all product lines in a wide range of colors and finishes, including custom color solutions upon request.

Over the years, HMI has evolved and adapted as market conditions, industry, and customer's needs have changed. The one thing that has remained constant is our commitment to customers, employees, and suppliers. Founded on strong Family values, and still driven by those same principles, our dedicated Team of professionals is committed to exceeding expectations by delivering quality products and service.

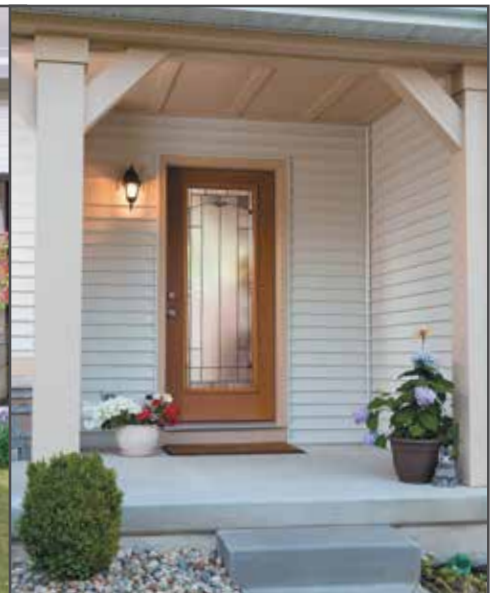



Endura Components..... 2-3
 Composite Door Frames..... 4
 Astragals & Hinge Options..... 5
 Trilennium 6
 Panolock + 7
 Frontline Cladding 8
 Finishing 9
 Fiberglass Collection..... 10-15
 HD Steel Collection..... 16-17
 Heritage Series Craftsman 18-19
 VistaGrande 6-8..... 20
 VistaGrande 8-0..... 21
 Aluminum SDL Kits 22-25
 Door Glass Blanca Textured 26-27
 Door Glass Decorative 28-36
 Door Glass Classic Series 37
 Door Glass Internal Blinds & Vents..... 38
 Door Glass External Muntins..... 39
 Door Glass Internal Muntins White..... 40
 Door Glass Internal Muntins Black 41
 DuraStyle Fir Craftsman Doors 42
 Special Order Vista Grande..... 43
 Special Order ODL 44
 Special Order RSL..... 45
 Special Order Fypon 46-47
 Special Order Wood Doors 48-49
 Door swings..... 50
 Wood Door Specifications 51
 Rough Openings 52
 Machining Specifications..... 53

Servicing Minnesota, Wisconsin,
 Eastern South Dakota and Northern
 Iowa

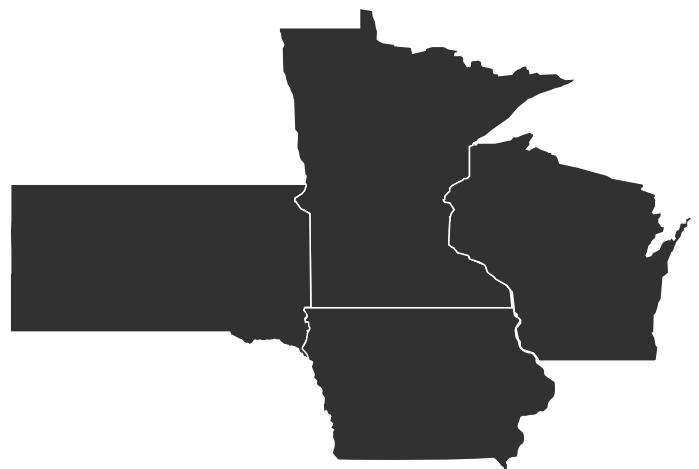

Heritage Millwork Inc
 6190 McKinley Street NW
 Ramsey, MN 55303
 763-323-7501 (p)
 888-323-7501 (p)
www.heritagemillworkinc.com

HERITAGECRAFT EXTERIOR DOOR SYSTEMS



Warranted quality and certified performance combine for a door system you can trust.

Certified Powered By Endura® Door Systems from Heritage Millwork are engineered and built to work from the ground up, with components designed and tested to work together for unmatched performance and durability. Every Certified Powered By Endura® System from Heritage Millwork has been strenuously tested and proven to outperform all others, even in imperfect conditions, delivering enhanced value and preventing costly service calls for a system that never stops working for you (or your wallet). But don't just take our word for it. Each system is backed by the industry's strongest lifetime warranty that's stamped right on the door, so you know you're covered by the best.



CERTIFIED POWERED BY ENDURA® TAG.



KEEP THE WEATHER OUT

Force 5 Door Bottoms

The Leading Edge Bulb Design provides a wider, stronger quality seal to keep back air and moisture. With the bulb design, a continuous seal forms along the dam, creating maximum area of surface contact between the door and sill so the door bottom fits securely. The bulb also retains its shape far longer than a fin design, providing long lasting performance.

Endura's door bottoms offer a superior barrier against air and water. The innovative designs and durable materials:

PE650 Weatherstrip



The memory of the weatherstrip is crucial so that when the door is opened, the weatherstrip springs back open and still functions when the door is closed again. Weatherstrip with poor memory

will crumble, bend & become ineffective.

Endura's weatherstrip:

- Snaps back into shape when bent or twisted
- PE650 with low wick foam absorbs over 50% less water

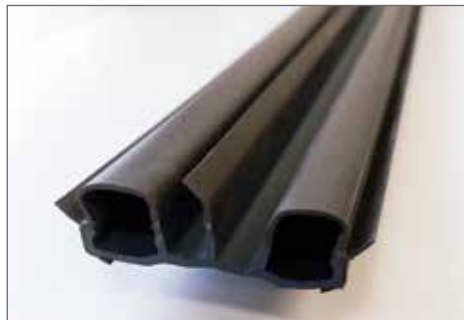

The Simple Solution® Corner Pad:

Enhanced performance in the real world. With wind or wind-driven rain, air pressure increases on the exterior side of a door system causing water to infiltrate the interior of homes that do not have proper door seals. The Simple Solution® is a compression corner weatherseal with a patented design to seal the door's weatherstripping at the crucial corner preventing water from percolating up and over the threshold.



Z-SERIES SILLS & FRAME SAVER



Using a patented design of all-synthetic components, the Z-Series Sill eliminates the worries of wood. Built to last, Z-Series Silles protect your entry from unsightly damage, rusted screws, discoloration, deformity, gaps and dents.

Z-Series Outswing Bumper Sill (mill finish instock)

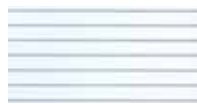

mill finish
(standard)



bronze



brass

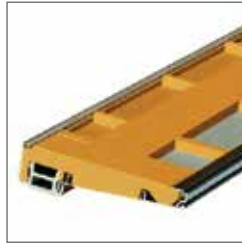

Composite Substrate

No more stuck doors or drafts because the Z-Series Sill substrate material is a **waterproof** composite that won't warp or rot, ever. The substrate is not affected by moisture and rot like wood.

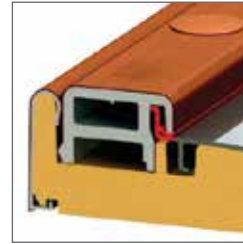

High Dam, Integrated Seal

Innovative cap design overlaps at the dam to provide a barrier against air and moisture, even in extreme weather conditions.

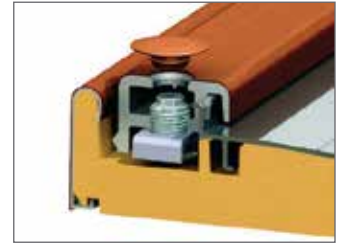

Sealed Adjustment Screws

Sealing plugs hide unsightly screws and keep water and dirt away from the adjustment mechanism, maintaining adjustability of the sill cap over time.



Look For The FrameSaver® Brand

FrameSaver® brand is stamped right into the product. This ensures builders and homeowners have FrameSaver® protecting the bases of their homes.



FrameSaver® Door Frames from Endura

are simply the best door frames on the market. They are so dependable that they come with a **lifetime**

transferable warranty that nobody can match. The patented composite bottom **won't absorb water**, warp, crack or rot and finishes and paints just like wood. FrameSaver's® finger-jointed wood composite protects the base of the frame from moisture exposure, and thus prevents water from wicking into the wood. **Rot never has a chance to begin.** That's Performance Standard.

Z-Series Articulating Cap Sill (special order)



The Z-Articulating Cap Sill™ (Z-AC) is a self-compensating cost-cutter that reduces the time and expertise needed to install a door unit, preventing performance issues that lead to door unit failure, and eliminating costly service calls, all while outperforming all others. The real world is never perfect, compensate with Z-AC. Heritage Millwork Inc is a certified Z-AC distributor. Special Order Only.

AVOID COSTLY REPAIRS - ROT PROOF



No matter how well a home is built, over time, water and insects will come in contact with exterior door frames, creating rot and the need for costly repairs. While others offer rot resistance, **only Endura FrameSaver®** offers guaranteed rot-proof performance. Simply the best door frame on the market, FrameSaver® even finishes and paints like wood.

US Patents: 6,219,971; 7,350,336; 8,413,383; 8,522,483; 8,991,100; 8,991,101; 9,371,682; 9,428,954; D571,932; D599,490; D722,387; D722,388; and US Patents Pending.
Canadian Patents: 2,771,705; 2,842,214; D153,751; D153,953; D165,013; D165,014 and Canadian Patents Pending.

COMPOSITE DOOR FRAMES

This innovative product is being stocked in both 4-9/16 and 6-9/16 jamb widths. Choose from either woodgrain or white cap.

The Composite Frame's unique formulation combines the strength and stability of wood without the rotting, warping and splitting.

The Composite Frame is resistant to mold, mildew, fungus, salt, chemicals, insects, and pollutants, leaving your entryway frame maintenance-free! The composite Frame has the same shape, designs, use, and functionality as wood frames, and can be similarly painted, stained, nailed, and machined.



White Cap



*Raw & Stained
Woodgrain*

Composite Frame Features

- Stocked in White Cap & Woodgrain
- 20 Minute Fire Rating
- Closed Cellular Structure - Will NOT absorb moisture
- Rigid Poly-Fiber Formulation
- No aluminium support channel needed
- Top-Notch Impact and Skin
- Two Times Screw Holding Power - Stronger than wood door frames
- Woodgrain jambs may be painted or stained
- White cap is a great alternative to clad

Composite Frame Stock Products

- Available for 6'8" and 8'0" Entry Units
- 4-9/16" & 6-9/16" Jamb
- 4-9/16" & 6-9/16" Wide Mull Posts
- Brickmold
- Sidelight stop



Woodgrain



White Cap



THE ULTIMATE FRENCH DOOR SOLUTIONS

ULTIMATE FLIP LEVER™ ASTRAGAL

Protects your home from infiltration with 4 weather sealing components working together. Spring loaded floating boot (1) forms a custom weathertight seal and works with the Simple Solution Corner Pad (2) to seal leaks at the base of the unit. When the bolt is retracted, the floating boot lifts clear of the sill protecting against wear and damage and guaranteeing a secure seal over time. Full-length sealing fin (3) works along with the weatherstrip (4) to fight infiltration from top to bottom.



Flip Lever

With Flip Lever, one flip is all you need to use the inactive door. **No more reaching or bending.**

Flip Lever Up

With the Flip Lever raised, the astragal boot and bolt are lifted clear of the seal for easy opening and closing of the door.

Flip Lever Down

As the Flip Lever is lowered, the Floating Boot forms a tight seal against the cap, while the Flush Bolt secures the unit in place.

HINGE COLORS

Self closing & ball bearing hinges available in select colors.

(outswing hinge colors other than stainless steel are not warranted against corrosion. HMI will not replace any of the below colors besides stainless steel for corrosion).

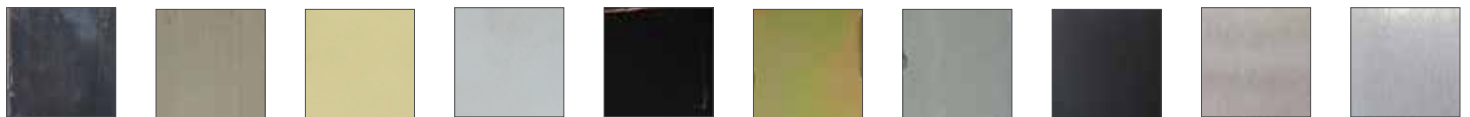

Antique Brass Antique Nickel Bright Brass Bright Chrome Colonial Bronze Dull Brass Dull Chrome Flat Black Satin Nickel Stainless Steel

	Antique Brass	Antique Nickel	Bright Brass	Bright Chrome	Colonial Bronze	Dull Brass	Dull Chrome	Flat Black	Satin Nickel	Stainless Steel
Ball Bearing Steel	X	X	X	X	X	X	X	X	X	
Ball Bearing Fiberglass	X		X		X	X	X	X	X	
Self Closing Steel	X	X	X	X	X	X	X	X	X	
Self Closing Fiberglass	X		X		X	X	X	X	X	
Outswing Steel	X	X			X	X			X	X
Outswing Fiberglass	X				X	X			X	X

HARDWARE OPTIONS

TRILENNIUM MULTI-POINT LOCK



Backed by the industry's highest ratings for structural and forced entry performance

Trilennium delivers 3x the strength, 3x the security and 3x the performance with one multi-point locking system. Plus, with Trilennium, unmatched protection doesn't have to mean compromised style. Trilennium offers a growing portfolio of attractive handset designs to suit any taste and budget.

UNMATCHED STRENGTH

Unlike flimsy competitors, Trilennium's one-piece I-Beam lock construction is so strong, it even strengthens the door panel.

RELIABLE SECURITY

Trilennium delivers the strength of 3 full deadbolts for uncompromised protection. No weak hooks or catches. Just tested, proven strength.

EASY, CONSISTENT OPERATION

Better than the competition, Trilennium is easy to use, activating with a single turn of the key or thumb turn, and releasing with just a single turn of the interior handle.

a single turn of the key or thumb turn, and releasing with just a single turn of the interior handle.

LASTING, FORGIVING PERFORMANCE

Trilennium corrects misalignment in 3 different directions, even fighting deflection when unlocked for lasting, error-free operation.

ADDITIONAL FEATURES

Offered in 1" and 7/8" widths, working seamlessly with proud edge/bull nose and standard book edge doors. SmartKey Compatible, Lasting performance and unmatched protection, a must-have for 8'0" door systems.



TRILENNIUM ENTRY HARDWARE

Designed for the locking system, Trilennium® hardware combines elegant design with precision engineering for beautiful, reliable performance.

Choose from an expansive portfolio of attractive handset designs to match your unique style and budget.

Trilennium is compatible with handset styles from Rocky Mountain Hardware, Emtek as well as Trilennium's own design selection, featured on this page.

Stock Colors: Black, Satin Nickel & Victorian Bronze.



Eclipse Entry Grip
Black or Victorian Bronze
(stock)



Rectangular
Black, Satin Nickel or
Victorian Bronze
(stock)



Eclipse
Satin Nickel
(stock)



Pinnacle
Victorian Bronze
(special order)



Horizon
Bright Brass
(special order)



Curved
Satin Nickel
(special order)

PANOLOCK+ MULTI-POINT LOCK



PanoLock®+ is the first and only multi-point lock that works with a wide variety of **off-the shelf hardware**, including electronic dead bolts! Affordable security and performance for every entry door!
(Handlesets not included)

Faceplate Finishes

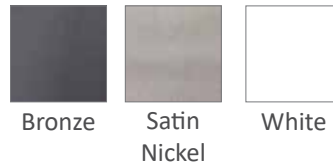

Adjustable Strike Plate Finishes

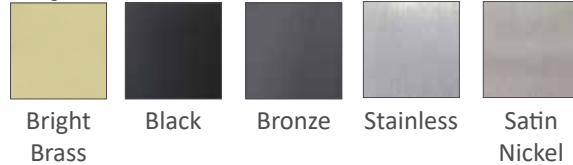

Astragal Finishes



SECURITY. PERFORMANCE. STANDARD.

Easy to live with. A simple turn of the deadbolt operates both tapered bolts smoothly and the handle-set operates the handleset latch. Three points of secure contact. PanoLock+ is easy to live with, even after years of use.

TESTED AND PROVEN.

PanoLock+ has been extensively tested and proven to perform, even in severe conditions. PanoLock+ withstood winds up to 200 mph in structural testing.

CHOOSE YOUR OWN HANDLESET



Works with a wide variety of standard hardware, including electronic deadbolts.* Use of multi-point locks has been limited due to high cost, difficult installation and operation, and the limitations of dedicated handleset hardware required for each lock offering. Not so with PanoLock®+.

SECURE PERFORMANCE

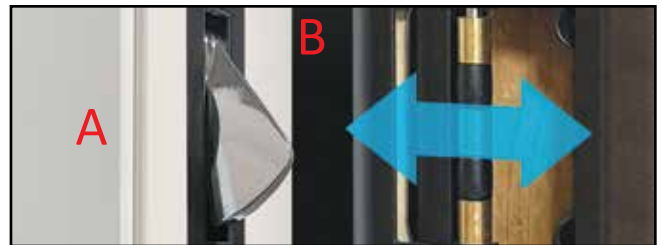

A. Tapered Bolt Unlike other locks that tend to catch, PanoLock+'s tapered bolts engage easily, even when the door is out of alignment.

B. Adjustable Roller Strike Rollers lower operating force allowing the tapered bolt to gently snug the door panel against the weatherstrip.



FRONTLINE CLADDING

ALUMINUM CLADDING FOR ENTRY DOORS

Cladding Benefits Include

- Eliminate Painting of Frame Trim
- No Maintenance
- No Warping or Water Wicking
- No chipping, no cracing, no peeling
- New or Existing Construction
- Heavy-duty .062 aluminum
- Three Profile Options
- Eight Stock Color Choices
- Four Special Order Color Choices

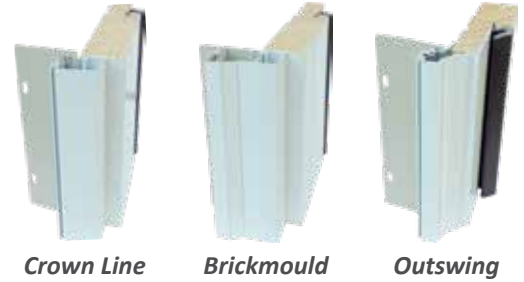

Crown Line

Brickmould

Outswing

Stock Colors Include: Frontline: White, Almond, Sandstone, Terratone, Bronze, Bahama Brown, Black, and Green.

Special Order Colors Include: Eggshell, Wineberry, Artic Silver and Beige



Frontline Sandstone Brickmold Clad

STOCK FRONTLINE CLAD COLORS (MATCHING PAINT AVAILABLE)



Frontline
White

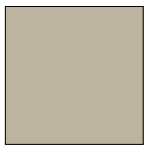

Frontline
Almond

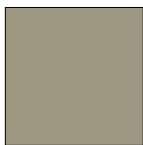

Frontline
Sandstone



Frontline
Terratone



Frontline
Bronze

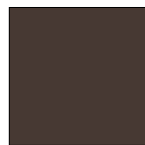

Frontline
Bahama Brown



Frontline
Black



Frontline
Green



Frontline
Wineberry
(special order color)

PRO-SERIES GARAGE DOOR CLAD FRAMES

Our Pro-Series Aluminum Garage Door Frames are pre-finished and maintenance-free. This is the perfect lifetime solution to no more paint

- Easy installation: Five minutes to assemble, twenty minutes to install
- Stocked with 90° square or 45° clipped corners (special order)
- .062 (16 gauge) extruded aluminum for strength and durability with composite insert
- Heavy-duty steel corner gussets for perfectly mitered corners
- No wood in frames means no rot, no water wicking, no warping, and no bug infestation
- Non Stock Optional 3-1/2" flat casing and J-mould (**both field applied**)
- Compliments the FrontLine entry door cladding system
- Limited Lifetime Warranty

Stock Colors Include: Black, Bronze, & White

Special Order Colors Include: Bahama Brown, Beige, Eggshell Green, Sandstone, Wineberry (extended lead time)

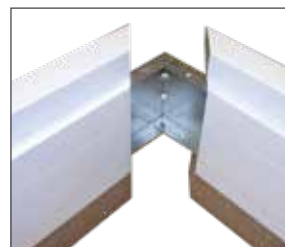

PROFESSIONAL PRE-FINISHING

FULL SERVICE PRE-FINISHING

Pre-Finishing your own products can be a long and daunting process. If not done properly you can ruin your doors and other millwork. However, pre-finishing needs to be done on all items in a timely manner, otherwise you can end up voiding the manufacture's warranty.

Heritage Millwork Inc, is proud to offer full service pre-finishing in our own state of the art finishing facility. We can finish all of your steel, fiberglass and wood exterior entry doors as well as interior doors, stair parts and millwork.

We offer 24 exterior paint colors and 8 exterior stain colors. Samples are available through one of our many dealers. Custom color matching is also available.

There is an extended lead time for pre-finishing but when your product arrives it will be ready to be installed.



8 STAIN COLORS
FOR EXTERIOR
TEXTURED FIBERGLASS DOORS
OR COMPOSITE FRAME



24 PAINT COLORS
FOR EXTERIOR STEEL OR
SMOOTH FIBERGLASS DOORS



See your local dealer for an actual color sample

FIBERGLASS DOOR COLLECTION

VistaGrande Premium Fiberglass Factory Glazed Low-E Glass 6'8"



VGF1L
Fir Textured Fiberglass



VGS1L
Smooth Fiberglass



VGF2L
Fir Textured Fiberglass



VGS2L
Smooth Fiberglass

FIBERGLASS DOOR COLLECTION

VistaGrande Premium Fiberglass Factory Glazed Low-E Glass 8'0"



VGF2L
Fir Textured Fiberglass



VGS2L
Smooth Fiberglass



FIBERGLASS DOOR COLLECTION

Heritage Series Premium Flat Panel Fiberglass



HF100

Fir Textured Fiberglass



HS100

Smooth Fiberglass
(optional 20 minute fire rated)



HF300

Fir Textured Fiberglass
(optional 20 minute fire rated)



HS300

Smooth Fiberglass
(optional 20 minute fire rated)

FIBERGLASS DOOR COLLECTION

Heritage Series Premium Flat Panel Fiberglass



HFC300

Fir Textured Fiberglass
(optional 20 minute fire rated)

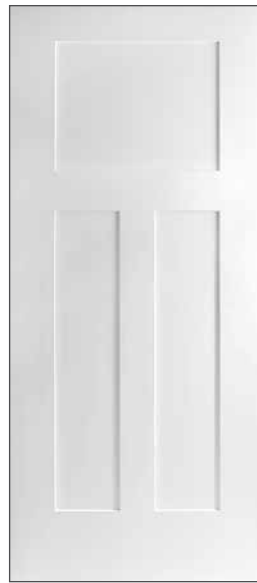

HSC300

Smooth Fiberglass
(optional 20 minute fire rated)



HF200

Fir Textured Fiberglass
(optional 20 minute fire rated)



HS200

Smooth Fiberglass
(optional 20 minute fire rated)



FIBERGLASS DOOR COLLECTION

Smooth Fiberglass

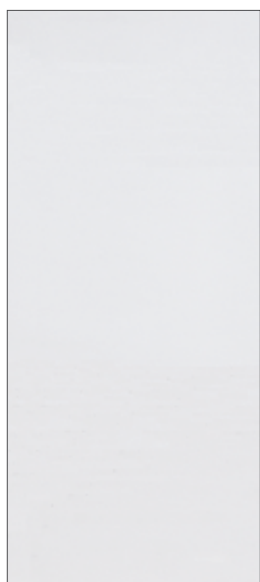

BS100
Smooth Fiberglass



BS600
Smooth Fiberglass
(optional 20 minute
fire rating)

FIBERGLASS DOOR COLLECTION

Textured Fiberglass



BT100
Oak
Textured Fiberglass



BT600
Oak
Textured Fiberglass



KA200
Knotty Alder
Textured Fiberglass



HD STEEL DOOR COLLECTION

Excel Smooth Wood Edge & Steel Edge Steel



E200



E200C



EW220



EW440

steel doors shown on these pages are 20 minute fire rated

HD STEEL DOOR COLLECTION

Excel Smooth Wood Edge & Steel Edge Steel



EW600



**E600
S600**



**EC300
SC300**



**E100
S100**

steel doors shown on these pages are 20 minute fire rated



HERITAGE SERIES

smooth fiberglass clear low-e glass



smooth



HSC1LE
clear low-e



HSC3LE
clear low-e 3 lite



HSC6LE
clear low-e 6 lite



HS192
clear low-e



HSC1LE
clear low-e



Optional dentil shelf available for all craftsman entry doors.

Heritage Series Authentic Craftsman Exterior Entry Doors are available with a Fir Texture Woodgrain or Smooth Surface

These flat 3 panel exterior fiberglass doors offer a fantastic curb appeal to your new or existing home.



HERITAGE SERIES

fir textured clear low-e glass



fir textured



HFC1LE
clear low-e 1 lite



HFC3LE
clear low-e 3 lite



HFC6LE
clear low-e 6 lite



HFC1LE
clear glass



HF192
clear glass



VISTA GRANDE 6'8"

factory flush-glazed clear low-e glass
fir textured & smooth fiberglass



fir fiberglass



smooth fiberglass



VGS1L
clear low-e



VGS2L
clear low-e



VGf1L
clear low-e



VGf2L
clear low-e



VGS192L
clear low-e



VGS322L
clear low-e



VGf192L
clear low-e

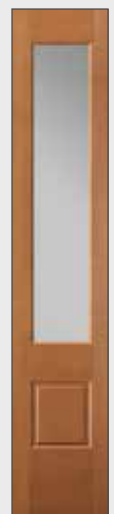

VGf322L
clear low-e

VistaGrande® Flush-Glazed doors offer a wider viewing area and cleaner appearance over traditional glass inserts. These doors will bring the natural light into your home. The stile and rail features provide an authentic wood door look.

Glass Size for Stock Doors 2'8" wide doors have a 22x64 glass size, 3'0" wide doors have a 26x64 glass size.

VISTA GRANDE 8'0"

factory flush-glazed clear low-e glass
fir textured & smooth fiberglass



fir fiberglass



smooth fiberglass



VGS2L
clear low-e

VGS322L
clear low-e



VGF2L
clear low-e



VGF322L
clear low-e



ALUMINUM SDL KITS

for VistaGrande 6'8" Smooth Fiberglass Doors

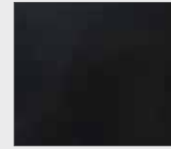

Black SDL
Frontline Black Finish

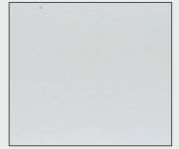

White SDL
Frontline White Finish

Kit Specifications

- Available for 2-8x6-8 and 3-0x6-8 VistaGrande Doors
- Black, White and Woodgrain profiles
- 3-1/2" or 1-1/8" wide
- For customization, black and white grilles have the option to be painted to match any of our 32 standard paint colors or left without paintings
- Woodgrain profiles can be stained or painted.

3-1/2" SDL



VGS3LH
3 Lite Horizontal



VGS4LH
4 Lite Horizontal



VGS1864L
4 Lite Horizontal



VGS1866L
6 Lite Traditional



VGS4L
4 Lite Traditional

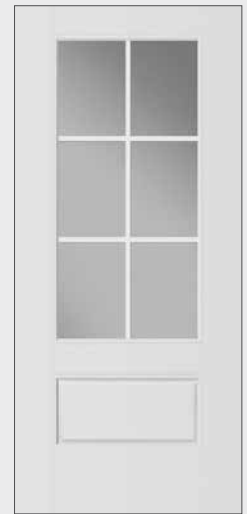

VGS6L
6 Lite Traditional

1-1/8" SDL

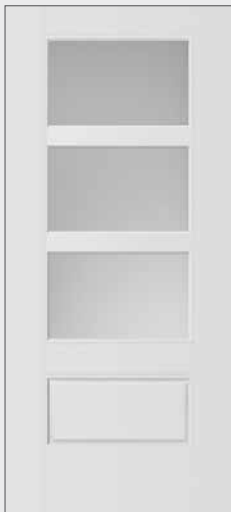

VGS3LH
3 Lite Horizontal

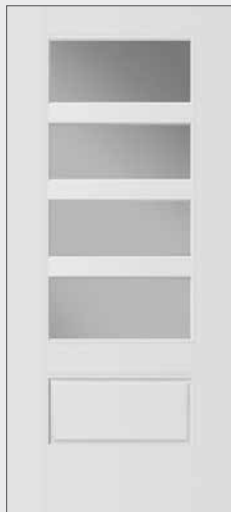

VGS4LH
4 Lite Horizontal



VGS133L
3 Lite Horizontal



VGS134L
4 Lite Horizontal



VGS112L
2 Lite Traditional



VGS113L
3 Lite Traditional



VGS312L
2 Lite Traditional



VGS313L
3 Lite Traditional



VGS333L
3 Lite Horizontal



VGS334L
4 Lite Horizontal

ALUMINUM SDL KITS

for VistaGrande 8'0" Smooth Fiberglass Doors

3-1/2" SDL

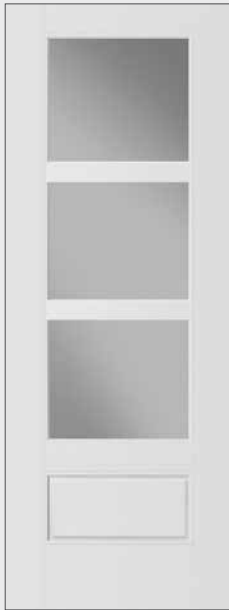

VGS3LH
3 Lite Horizontal



VGS4LH
4 Lite Horizontal

1-1/8" SDL



VGS4L
4 Lite Traditional

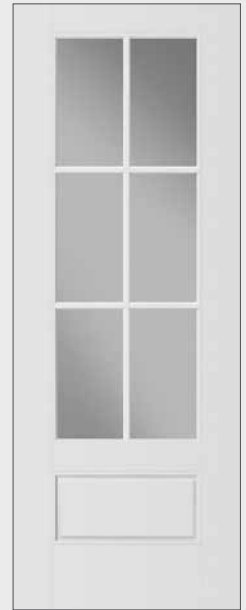

VGS6L
6 Lite Traditional



VGS333L
3 Lite Horizontal



VGS334L
4 Lite Horizontal



VGS112L
2 Lite Traditional



VGS113L
3 Lite Traditional



ALUMINUM SDL KITS

for VistaGrande 6'8" Fir Fiberglass Doors



Woodgrain Grille
Shown in Summit Stain



Woodgrain Grille
No Finish

3-1/2" SDL

1-1/8" SDL



VGF3LH
3 Lite Horizontal



VGF4LH
4 Lite Horizontal



VGF1864L
6 Lite Traditional



VGF1866L
6 Lite Traditional



VGF4L
4 Lite Traditional



VGF6L
6 Lite Traditional



VGF3LH
3 Lite Horizontal



VGF4LH
4 Lite Horizontal



VGF133L
3 Lite
Horizontal



VGF134L
4 Lite
Horizontal



VGF112L
2 Lite
Traditional



VGF113L
3 Lite
Traditional



VGF312L
2 Lite
Traditional



VGF313L
3 Lite
Traditional



VGF333L
3 Lite
Horizontal



VGF334L
4 Lite
Horizontal

ALUMINUM SDL KITS

for VistaGrande 8'0" Fir Fiberglass Doors

3-1/2" SDL



VGF3LH
3 Lite Horizontal



VGF4LH
4 Lite Horizontal

1-1/8" SDL



VGF4L
4 Lite Traditional



VGF6L
6 Lite Traditional

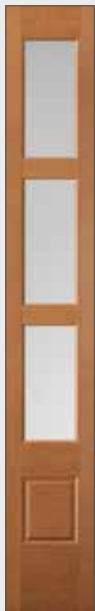

VGF333L
3 Lite Horizontal



VGF334L
4 Lite Horizontal



VGF112L
2 Lite Traditional



VGF113L
3 Lite Traditional



FIR CRAFTSMAN

DuraStyle Exterior Wood Doors



true divided lite



DF2632
Low-E Glass
Raised Panel



DF2662
Clear Glass
Raised Panel



DF1761
Clear Glass
Raised Panel



Your new wood door is beautiful. Our job is to help keep it looking just like new. AquaSeal can deliver up to 22 times the protection against water penetration compared to exterior wood doors without AquaSeal preserving the door's natural beauty.

HERITAGE SERIES FIBERGLASS

Clear Low-E Glass



HF3HM1LE
Fir Texture Fiberglass
Low-E Glass



HF3HM3LE
Fir Texture Fiberglass
Low-E Glass



HS3HM1LE
Smooth Fiberglass
Low-E Glass



HS3HM3LE
Smooth Fiberglass
Low-E Glass



BLANCA (SATIN)

perspectives textured door glass



186BLC
(E, S, BS, BT)



227BLC
(E)



447BLC
(E)



684BLC
(E, S, BS, BT)



284BLC
(E, KA)



194BLC
(E, BS, BT)



322BLC
(E)



292BLC
(E, BS, BT)

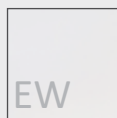
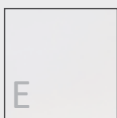
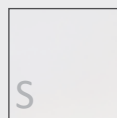
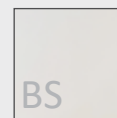
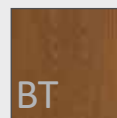
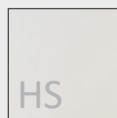
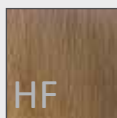
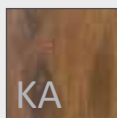



Privacy Rating = 9

BLANCA (SATIN)

perspectives textured door glass



CBLC
(E, S)

CBLC
(E)



CBLC
(HF, HS)

CBLC
(HF, HS)



CBLC
(HF, HS)

CBLC
(HF, HS)



door key: KA - Knotty Alder HF - Heritage Fir HS - Heritage Smooth BT - Belleville Textured Oak BS - Belleville Smooth S - Sterling E - Excel EW - Excel White

DORIAN

black aluminum caming



Privacy Rating = 8

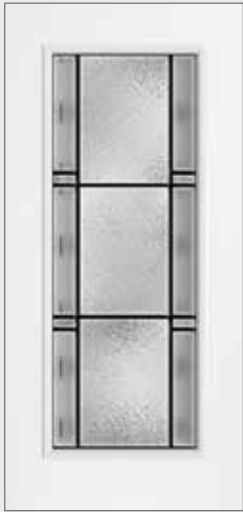

186DOR
(E, S, BS, BT)



227DOR
(E)



447DOR
(E)



194DOR
(E, BS, BT)

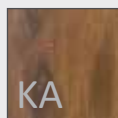

KA

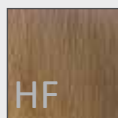

HF

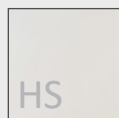

HS

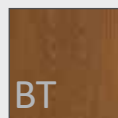

BT

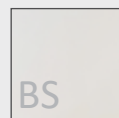

BS

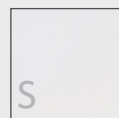

S

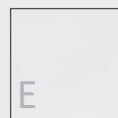

E



EW



Privacy Rating = 7

ELEMENT

patina coming



ECEL
(E, S)

CEL
(E)



HSCCEL
(HS)

HSCCEL
(HS)



HFCEL
(HF)

HFCEL
(HF)



door key: KA - Knotty Alder HF - Heritage Fir HS - Heritage Smooth BT - Belleville Textured Oak BS - Belleville Smooth S - Sterling E - Excel EW - Excel White

GRACE

nickel caming



Privacy Rating = 7



186GRC
(E, S, BS, BT)



227GRC
(E)



447GRC
(E)



492GRC
(E)



684GRC
(E, S, BS, BT)



284GRC
(E, KA)



194GRC
(E, BS, BT)



322GRC
(E)



292GRC
(E, BS, BT)

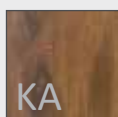

KA

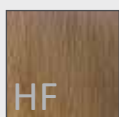

HF

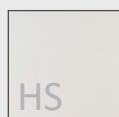

HS

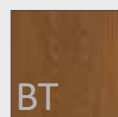

BT

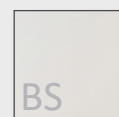

BS

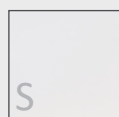

S

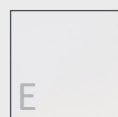

E

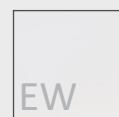

EW

MASTER NOUVEAU

patina coming



Privacy Rating = 6

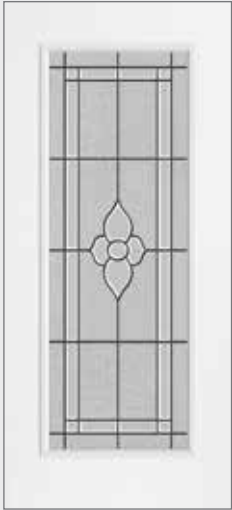

186MNP
(E, S, BS, BT)

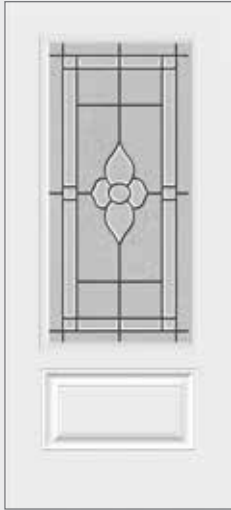

227MNP
(E)

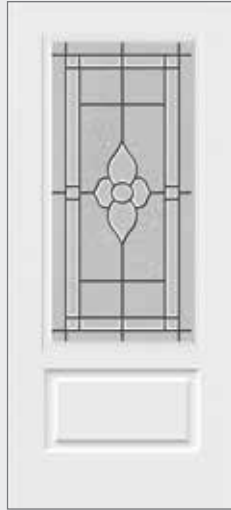

447MNP
(E)



684MNP
(E, S, BS, BT)

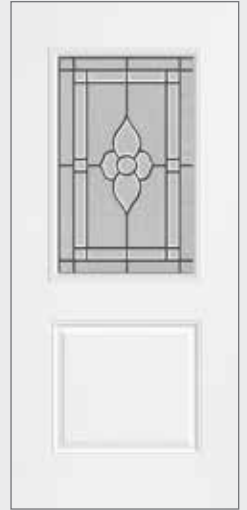

284MNP
(E, KA)

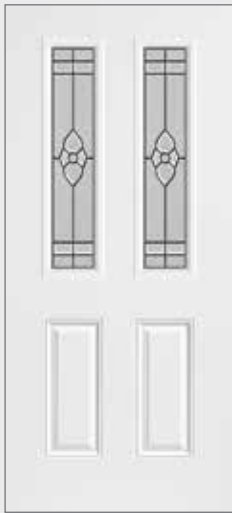

492MNP
(E)

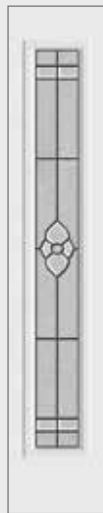

194MNP
(E, BS, BT)



322MNP
(E)



292MNP
(E, BS, BT)

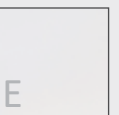
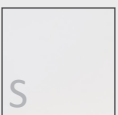
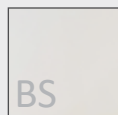
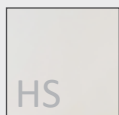
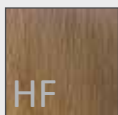
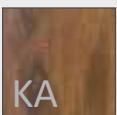

NAPLES

patina caming

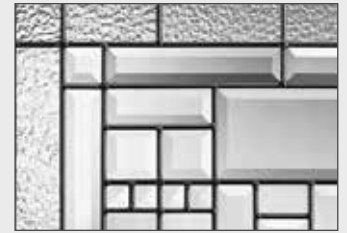

Privacy Rating = 7



ECNA
(E, S)



HFCNA
(HF)



HSCNA
(HS)



CNA
(E)



HFCNA
(HF)



HSCNA
(HS)

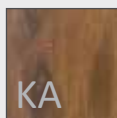

KA

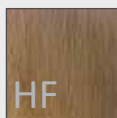

HF

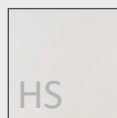

HS

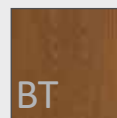

BT

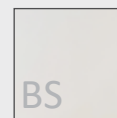

BS

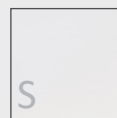

S

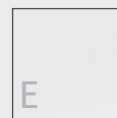

E

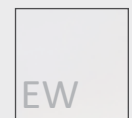

EW



OAK PARK

patina coming

Privacy Rating = 5

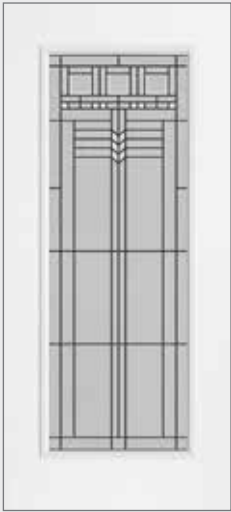

186OP
(E, BS, BT)

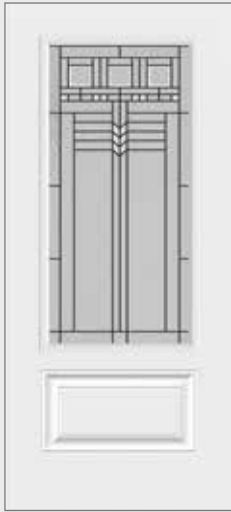

227OP
(E)

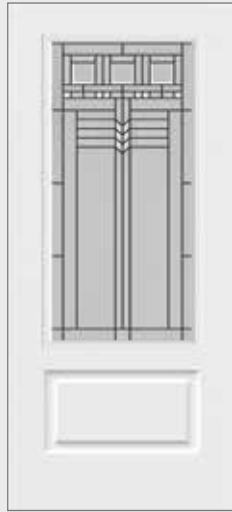

447OP
(E)

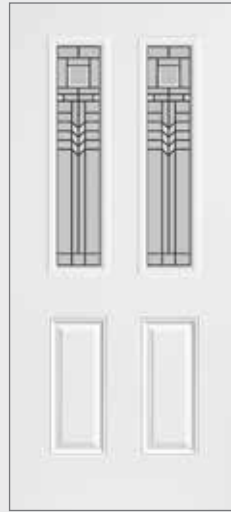

492OP
(E)

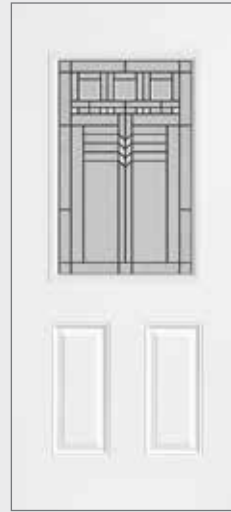

684OP
(E, S, BS, BT)

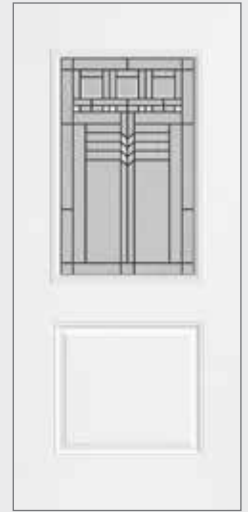

284OP
(E, KA)



COP
(E, S)



COP
(HF, HS)

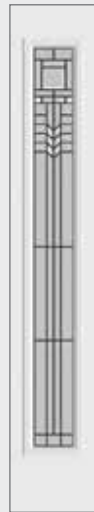

194OP
(E, BS, BT)



322OP
(E)



292OP
(E, BS, BT)

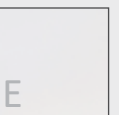
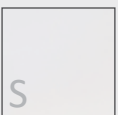
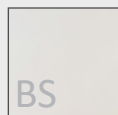
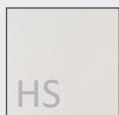
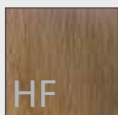
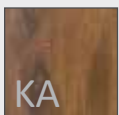

PARAGON

patina coming



Privacy Rating = 4



186PRG
(E, S, BS)



227PRG
(EW)



447PRG
(EW)



194PRG
(E, BS)



207PRG
(E)

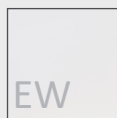
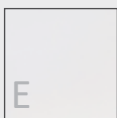
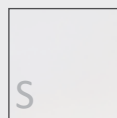
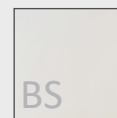
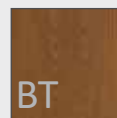
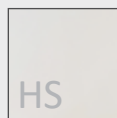
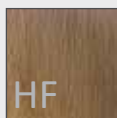
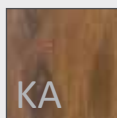



PARIS

patina caming

Privacy Rating = 4

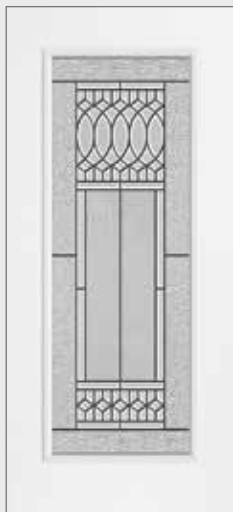

186PS
(E, S, BS, BT)



227PS
(E)

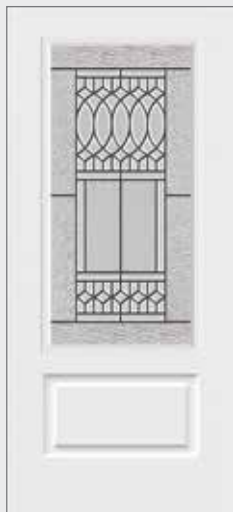

447PS
(E)



492PS
(E)



684PS
(E, S, BS, BT)



284PS
(E, KA)



CPS
(E, S)



194PS
(E, BS, BT)



292PS
(E, BS, BT)

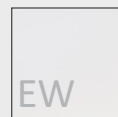
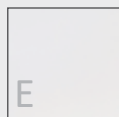
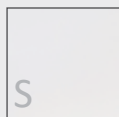
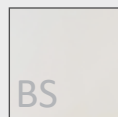
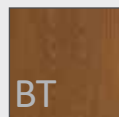
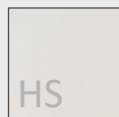
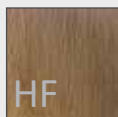
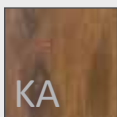

TOPAZ

patina coming



Privacy Rating = 9

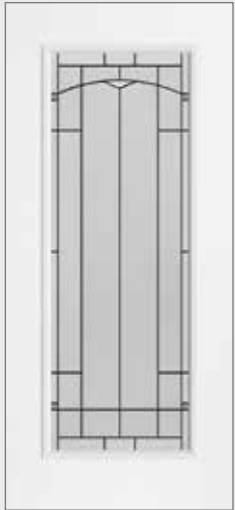

186TPZ
(E, S, BS, BT)

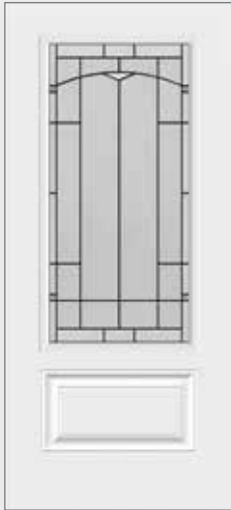

227TPZ
(E)

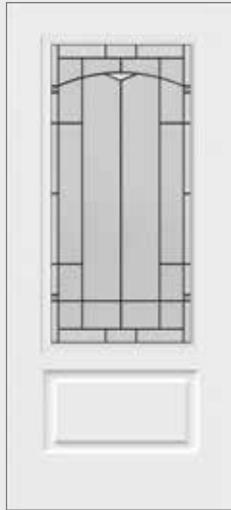

447TPZ
(E)



492TPZ
(E)



684TPZ
(E, S, BS, BT)



284TPZ
(E, KA)



CTPZ
(E)



CTPZ
(HF, HS)



194TPZ
(E, BS, BT)

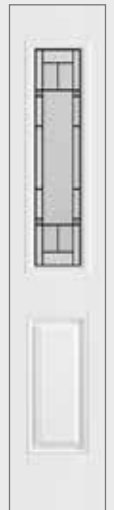

292TPZ
(E, BS, BT)

CLASSIC SERIES

clear insulated glass (I) & clear low-e (L)



186I
(E, S, BS)

186L
(E, S, EW, BS, BT)



684I
(E, EW, S, BS)

684L
(E, EW, S, BS, BT)



284I
(E, KA)

284L
(E, KA)



492I
(E)

492L
(E)



227L
(EW)



447L
(EW)

Rain Glass



CRN
(E, S)



CRN
(HF, HS)



C1LE
(E, S)



C1LE
(E)



Direct Set
Sidelite



194I
(E, BS)

194L
(E, BS, BT)



322L
(E)



292I
(E, BS)

292L
(E, BS, BT)



Direct Set Transom
3012LE
(36" x 12")
4012LE or 4214LE
(48" x 12" or 50" x 14")



Direct Set Transom
5012LE or 5414LE
(60" x 12" or 64" x 14")
5016LE or 5422LE
(60" x 16" or 64" x 22")

INTERNAL BLINDS (IMB)

clear glass - raise, lower & tilt



186IMB
(E, EW, S, BS)



684IMB
(E, EW, S, BS)



284IMB
(E, KA)



492IMB
(E)



292IMB
(E, BS)



194IMB
(E, BS)

Pro-Series Vents (IVT)



684IVT
(E, EW, S, BS)



- Interlocking rails with double seals ensure a tight fit to resist air and water infiltration
- Frames are UV resistant; never needs painting and resists cracking and yellowing
- Screen removable from outside only

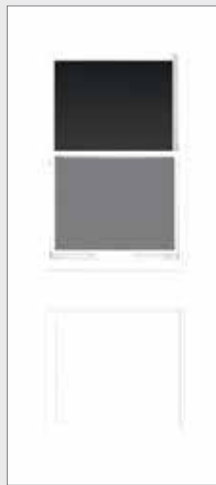

284IVT
(E, KA)

Classic Series clear insulated glass (I)



460I
(E)



680I
(E, EW)

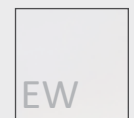
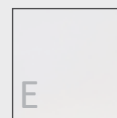
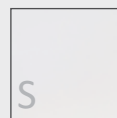
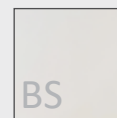
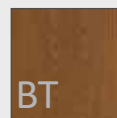
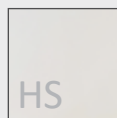
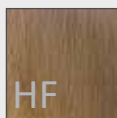
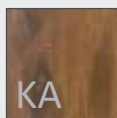



EXTERNAL MUNTINS

clear insulated glass (I) & clear low-e (L)

White (M)

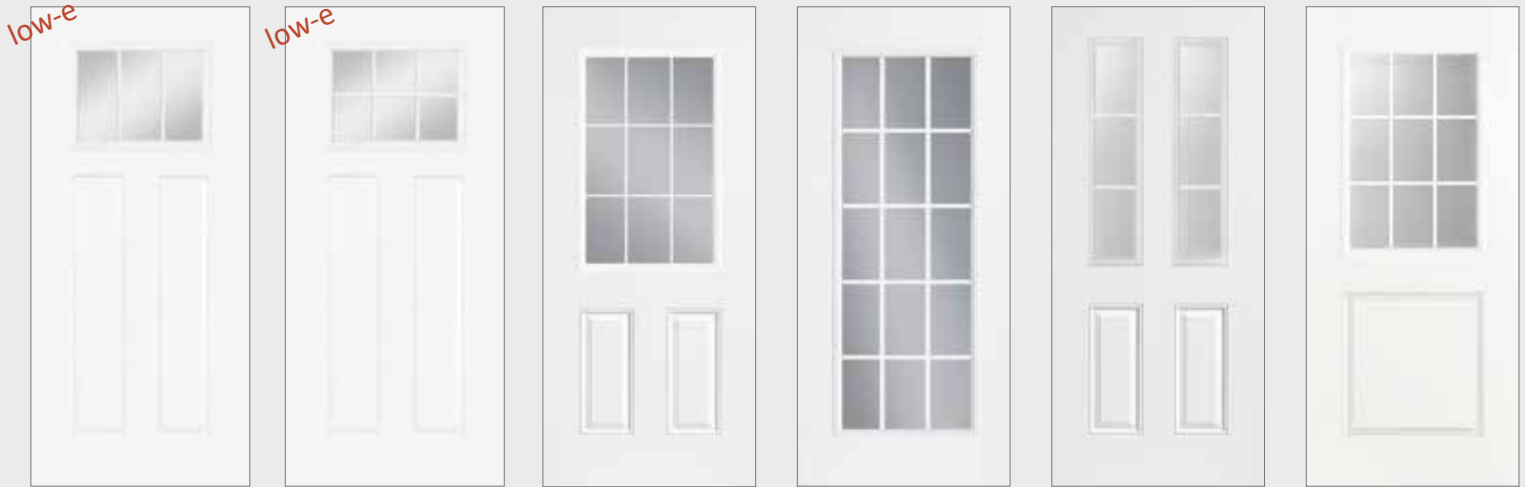

C3LE
(E, S)

C6LE
(E, S)

684IEM
(E, EW, S, BS)

186IEM
(E, EW, S, BS)

492IEM
(E)

284IEM
(E, KA)



Direct Set Transom
3012GBGLE
(36" x 12")



Direct Set Transom
5012GBGLE or 5414GBGLE
(60" x 12" or 64" x 14")

4012GBGLE or 4214GBGLE
(48" x 12" or 50" x 14")



194IEM
(E, BS)



292IEM
(E, BS)



Direct Set Sidelite
Clear IG
or Low-E



Door: E684IEM White External Muntin, Clear Glass, Finished Wineberry

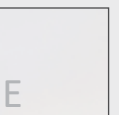
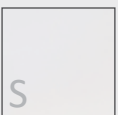
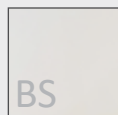
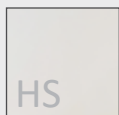
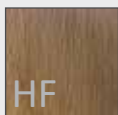
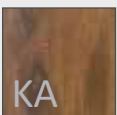

INTERNAL MUNTINS

clear insulated glass



White (M)



460IIM
(E)



464IIM
(E, EW)



492IIM
(E)



194IIM
(E, BS)



292IIM
(E, BS)



292PIM
(E, BS)



194PIM
(E, BS)



Direct Set Transom
(M)
(48" x 12" or 50" x 14")



Direct Set Transom
(M)
(60" x 12" or 64" x 14")



684IIM
(E, EW, S, BS)



684PIM
(E, S, BS)



284IIM
(E, KA)



284PIM
(E, KA)



186IIM
(E, S, BS)



186PIM
(E, S, BS)

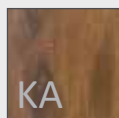

KA

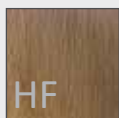

HF

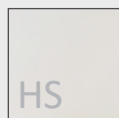

HS

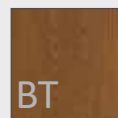

BT

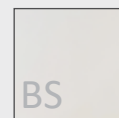

BS

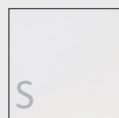

S

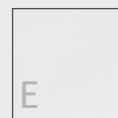

E

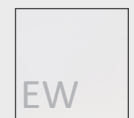

EW



INTERNAL MUNTINS

clear low-e glass

Black (B)

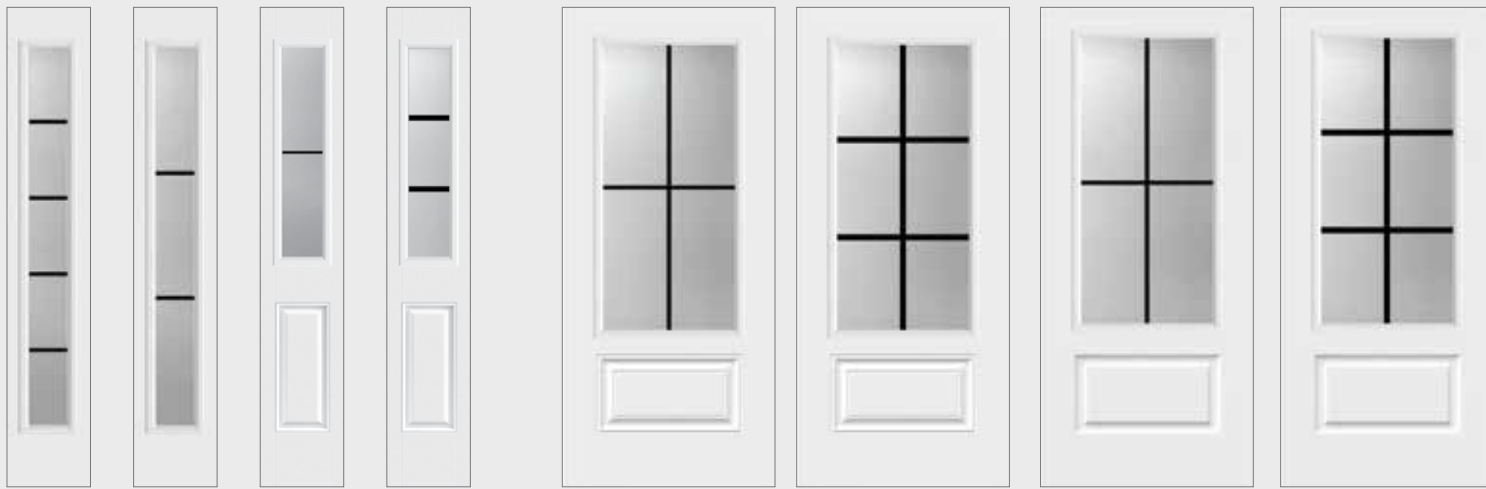

194LIB (E, BS) 194LIB3 (E, BS) 292LIB2 (E, BS) 292LIB (E, BS)

227LIB4 (E)

227LIB6 (E)

447LIB4 (E)

447LIB6 (E)

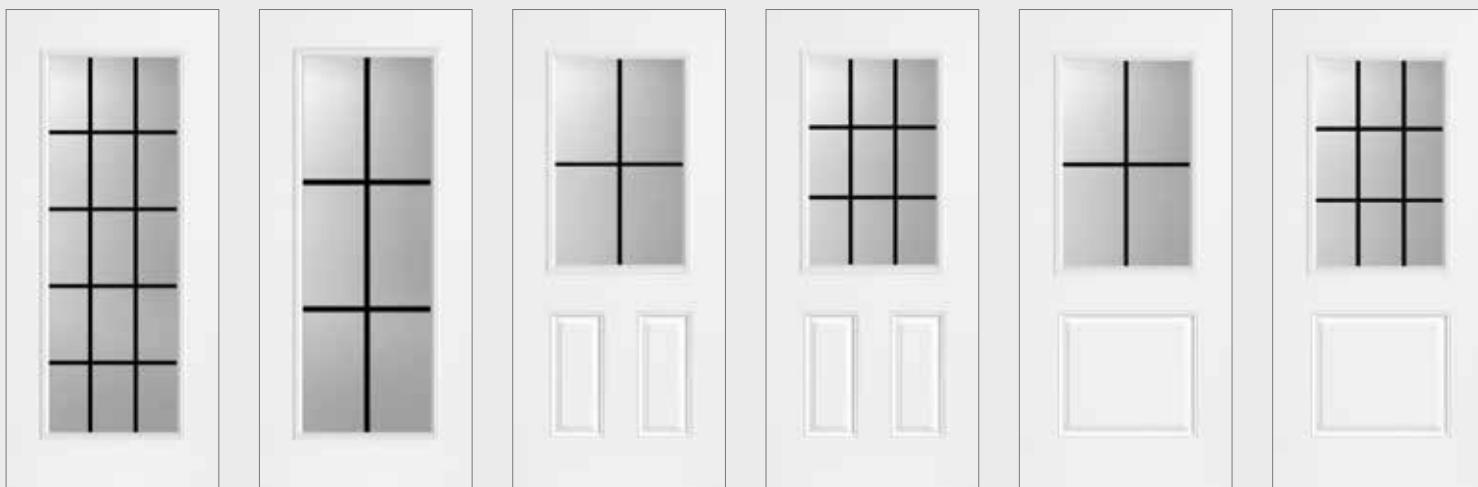

186LIB (E, S, BS)

186LIB6 (E, S, BS)

684LIB4 (E, S, BS)

684LIB (E, S, BS)

284LIB4 (E, KA)

284LIB (E, KA)



ODL SPECIAL ORDER EXTERIOR GLASS

for steel and fiberglass doors

Products that make an entrance. Add flair to your front door. ODL offers hundreds of door glass combinations, from clear to complete privacy, ODL has it all. To see all options, visit www.odl.com.

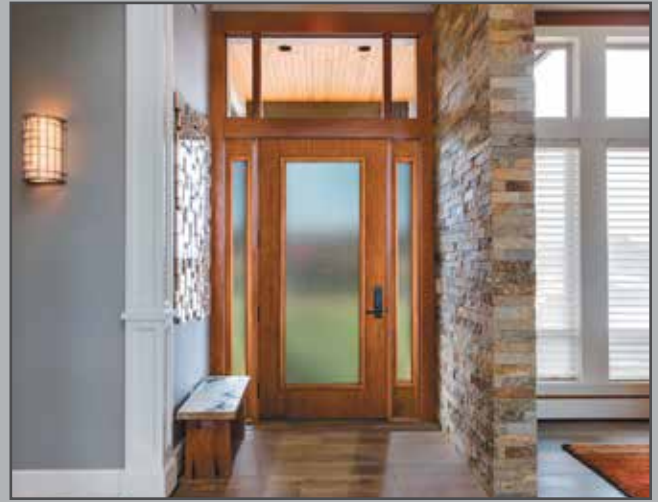

186 Door
22x64 Chinchilla Glass



186 Door
22x64 Cumulus Glass

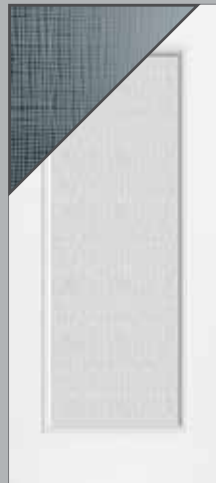

186 Door
22x64 Linen Glass

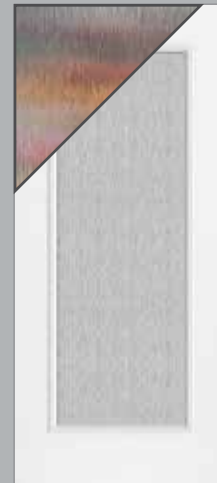

186 Door
22x64 Streamed Glass



186 Door
22x64 Vapor Glass



E447 Door
22x48 Berkley Glass



E447 Door
22x48 Calandra Glass



E447 Door
22x48 Neo Glass



186 Door
22x64 Amadeus Glass



186 Door
22x64 Baypoint Glass

RSL - SPECIAL ORDER

steel doors with decorative glass

RSL's doorglass is unique in its attention to detail and craftsmanship. Every piece of beveled glass is hand cut and polished with rigorous inspection to ensure our stringent quality by design standards are achieved. The patterns used in assembling our decorative doorglass are made up of handcrafted glass. They are not machine manufactured to be identical and standard in appearance. Our glass is artistic and individually textured with slight bubbles, lines and surface variations. These are natural characteristics of decorative glass and are not defects.



E447 Door
22x48 Avenue Glass



E447 Door
22x48 Placid Glass



E227 Door
22x48 Opal Glass



E227 Door
22x48 Summit Glass



E227 Door
22x48 Bolero Glass



186 Door
22x64 Avenue Glass



186 Door
22x64 Placid Glass



186 Door
22x64 Opal Glass



186 Door
22x64 Summit Glass

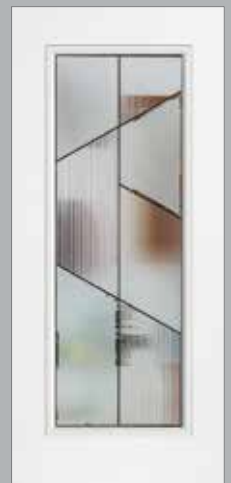

186 Door
22x64 Bolero Glass

FYPON - SPECIAL ORDER

Flat-Pack Column Wraps EverCedar & Smooth

Fypon EverCedar wood-grained flat-pack column wraps provide the charming, on-trend aesthetic of real cedar without the hassle. Both the EverCedar & Smooth are both Flat-pack column wrap products and ship unassembled for better handling and utilization of less storage space. Ease of assembly and installation is maintained, without sacrificing performance.



Square

Widths: 6", 8", 10", 12"
Heights: 96", 108", 120"



Tapered

Widths: 8" x 12", 11" x 16"
Heights: 48", 54", 60", 66", 72", 96"



SPECIAL ORDER - Wood-Grain Beams & Trusses



Rough Sawn



Mesa

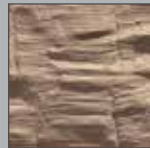

Hand Hewn

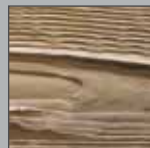

Tahoe



VISTA GRANDE - SPECIAL ORDER

fir textured fiberglass, factory flush glazed glass



**VistaGrande
SDL**
clear glass



**VistaGrande
Internal Mini Blind**
clear glass



**VistaGrande
SDL**
clear glass



**VistaGrande
SDL**
chord glass



**VistaGrande
SDL**
quill glass



**VistaGrande
8'-0" SDL**
clear glass



**VistaGrande
8'-0" SDL**
double water glass

ARTISAN WOOD DOOR COLLECTION

special order extended lead time



PANEL & STICKING SELECTION FOR EXTERIOR WOOD DOORS

Flat panel, raised panel with single or double hip.

These panel configurations are available for *Artisan* and *Le Chateau* Wood Doors.

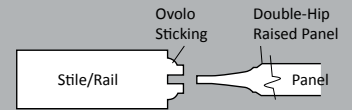
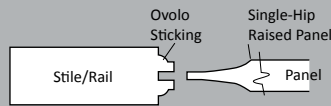
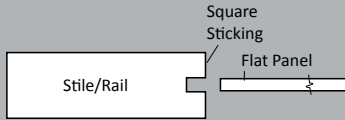

GLASS SELECTION FOR EXTERIOR WOOD DOORS

Crystal clear or opaque, patterned or plain, the glass you choose should be a reflection of your personal taste. Choose from a wide array of glazing options, making it easy to achieve the look and level of privacy you desire. Many of the designs below are available with beveling, IG and Low-E options. These glass options are available for *Artisan* and *Le Chateau* Wood Doors.



LE CHATEAU WOOD DOOR COLLECTION

special order extended lead time



Panels can be removed and glass added to any design. Hundreds of additional panel designs available.

STILE AND RAIL DOORS DEFINED

- Mullion: Narrow vertical sections between panels
- Muntin: Slim vertical pieces used to separate panes of glass; grill bar
- Panel: Pieces that fit within the surrounding stile & rail frame that come in different profile designs (single hip, double hip, flat)
- Rail: Horizontal pieces of the door; includes top, bottom and sometimes lock rail
- Sticking: The design of the profile edge on the stile and rail; ovolo is carved and rounded; shaker is straight & squared
- Stile: Vertical pieces of the door

WOOD SELECTIONS FOR EXTERIOR DURASTYLE™ WOOD DOORS

From the rich elegance of mahogany to the rustic charm of knotty alder, picking a wood species to achieve the look that defines your style. Choose from 8 stain grade species. All species shown below are available for *Artisan* or *Le Chateau* Wood Doors.

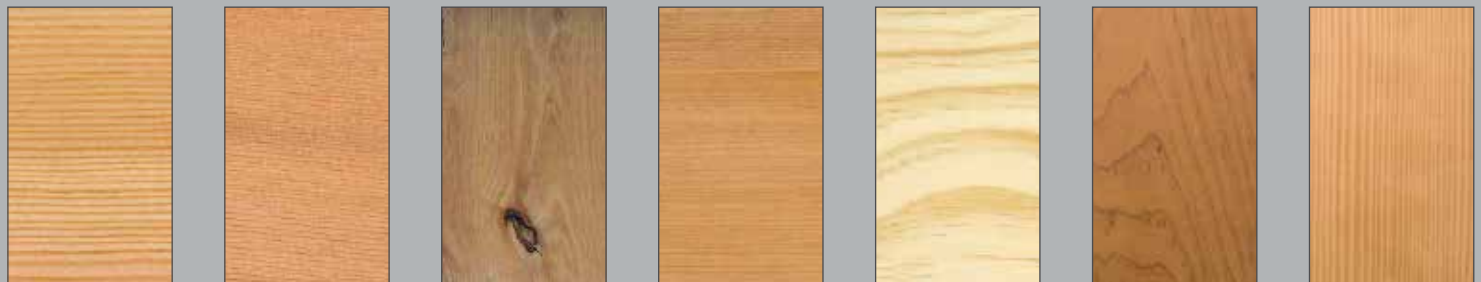

FIR HEMLOCK KNOTTY ALDER MAHOGANY PINE TORREFIED MAPLE TORREFIED FIR

DETERMINING DOOR SWING

steel, fiberglass & wood pre-hungs



Interior

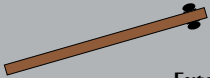

Exterior

Inswing Single Door
Left Hand



Interior

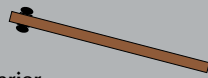

Exterior

Inswing Single Door
Right Hand



Interior



Exterior

Outswing Single Door
Right Hand



Interior



Exterior

Outswing Single Door
Left Hand



Interior



Exterior

Inswing Double Door
Left Hand Active
Astragal installed on
Right Hand Door



Interior

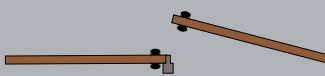

Exterior

Inswing Double Door
Right Hand Active
Astragal installed on
Left Hand Door



Interior

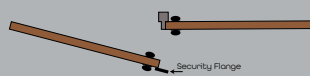

Exterior

Outswing Double Door
Right Hand Active
Astragal installed on
Left Hand Door



Interior

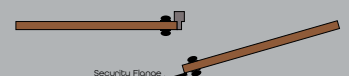

Exterior

Outswing Double Door
Left Hand Active
Astragal installed on
Right Hand Door

WOOD DOOR specifications

DuraStyle

The difference is clear: AquaSeal can deliver up to 22 times the protection against water penetration compared to exterior wood doors without AquaSeal preserving the door's natural beauty.



Glass & Panels w/ AquaSeal Technology

DuraStyle wood doors keep the water out

AquaSeal keeps water and moisture out of panel edges and glass inserts. 2-ply solid panels provide sturdy construction. The MR50 exterior grade core maximizes water resistance.

AquaSeal applied around panels and glass

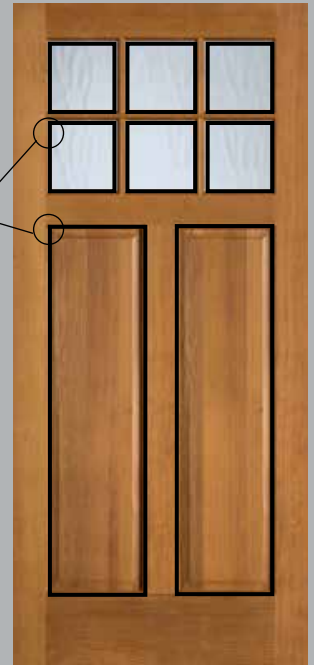

DuraStyle Torrefied Wood Doors

Design the perfect fit for your home with Masonite's DuraStyle torrefied Collection. These premium exterior wood doors let you have it all without compromise. Our one-of-a-kind, handcrafted, solid wood doors have the highest levels of performance in the market. We're so confident that we back each wood door with a 20-year limited warranty without an overhang requirement. Design your perfect door with hundreds of unique panel and glass options.

LVL Core

LVL stiles and rails offer stability and no warping



Laminated veneer lumber (LVL) derives its strength from an impressive number of tightly-bonded wood veneers glued together layer upon layer, forming a solid Tension-resistant core. Since the layers of veneer are arranged on edge, our lvl core withstands all tendency to warp and twist. Available in all species, panels, glasses and designs.

Fire Rating

Masonite carries a full line of fire-rated doors and jambs. In sizes up to 4/0 width and 8/0 height, and are available in a range of custom sizes and designs, with either a primed paint finish, or a choice of 15 different species of stain grade. Benefit from the advantages of using a single source for all your fire-rated door requirements. Masonite doors and jambs fit with a quality and durability nothing short of enviable. It's no longer a choice between form and function, because Masonite's fire-rated door products afford your clients the peace of mind they need, and the great looks they want.

Overhang Coefficient (requirements) Exposure

Standard exterior wood doors must be protected from the elements. Sun, rain, and snow can break down the finish on your door and cause performance issues.

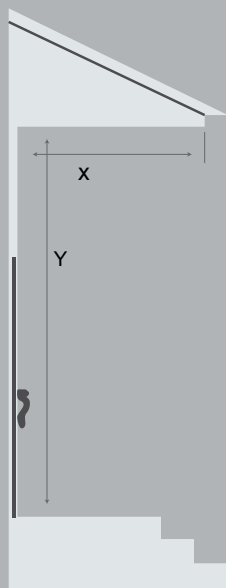

Here are the manufactures requirements for the overhang of a **wood exterior door**. If your door faces North or East, the minimum required overhang (including left and right of the door) is equal to one half the distance from the sill to the overhang. If your door faces South or West, the minimum overhang requirement is equal to the distance from the sill to the overhang. (See illustrations below)

The Torrefied Collection of exterior doors, does not require an overhang. If your location does not allow for the proper overhang for a standard wood door, please select a door from our Torrefied Wood Door Collection.

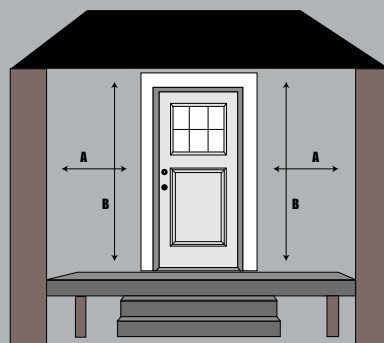

North or East $X = 1/2$ of Y **South or West** $X = Y$
North or East $A = 1/2$ of B **South or West** $A = B$

ROUGH OPENINGS

steel, fiberglass & wood pre-hungs

STEEL, FIBERGLASS & WOOD PREHUNG ROUGH OPENINGS

with standard continuous head and sill on all mull units

Door Width	Single Door	W/One 1-0 SL	W/Two 1-0 SL	W/One 1-2 SL	W/Two 1-2 SL	Double Door
2'-6"	32-1/2"	46"	59-1/2"	48"	63-1/2"	63"
2'-8"	34-1/2"	48"	61-1/2"	50"	65-1/2"	67"
3'-0"	38-1/2"	52"	65-1/2"	54"	69-1/2"	75"
3'-6"	44-1/2"	58"	71-1/2"	60"	75-1/2"	87"

6-8" door (inswing) = 82-1/2" Rough opening height

6-8" door (outswing) = 81-5/8" Rough opening height

6-8" door (low-profile) = 81-1/2" Rough opening height

6-8" door & 12" rect transom (stock sizes) = 96" Rough opening height (inswing)

6-8" door & 14" rect transom (stock sizes) = 98" Rough opening height (inswing)

8-0" door (inswing) = 98-1/2" Rough opening height

8-0" door (outswing) = 97-5/8" Rough opening height

8-0" door (low-profile) = 97-1/2" Rough opening height

8-0" door & 12" rect transom (stock sizes) = 112" Rough opening height (inswing)

8-0" door & 14" rect transom (stock sizes) = 114" Rough opening height (inswing)

Outside of frame width (no brickmould) = subtract - 1" from rough opening

Outside of frame height (no brickmould) = subtract - 1/2" from rough opening

Outside of brickmould width = add+ 1-1/2" to rough opening

Outside of brickmould height = add+ 3/4" to rough opening

For Brickmould Clad outside of brickmould width = add+ 1-1/2" to rough opening

For Brickmould Clad outside of brickmould height = add+ 3/4" to rough opening

For outside of crownline clad width = add+ 1/8" to rough opening

For outside of crownline clad height = add+ 1/16 to rough opening

Masonry Opening = 1/4" wider than brickmould or crownline width. 1/8" taller than brickmould or crownline height

Masonry Opening for OUTSWING Clad width = Standard R.O. (listed in chart above) + 1/4"

6-8" door Masonry Opening for OUTSWING Clad height = 81-5/8"

8-0" door Masonry Opening for OUTSWING Clad height = 97-5/8"

Note: We reserve the right to make changes in specifications, construction, design and details at any time.

Corrections to reflect such changes will be included in subsequent printings of this publication.

MACHINING SPECS

steel, fiberglass & wood pre-hung

HERITAGE STANDARD MACHINING SPECS

All measurements shown are from the top of the door to the top of the hinge and the top of the door to the center of bore.

3-0 & 3-6 steel & fiberglass doors are bored 2-3/4" backset.

2-6 & 2-8 steel & fiberglass doors are bored 2-3/8" backset.

All widths of Stile and Rail Wood doors are bored 2-3/8" backset

All doors have a 2-1/8" diameter face bore, and a 1" x 2-1/4" mortise edge prep (ANS 9206), unless specified otherwise.

Steel & fiberglass doors are machined for a 4" x 4" butt hinge.

Wood stile and rail doors are machined for a 4"x 4" radius radius hinge.

Exterior Wood slab only doors are shipped are full and square.

Steel and Fiberglass slabs are 1/4" undersized in width

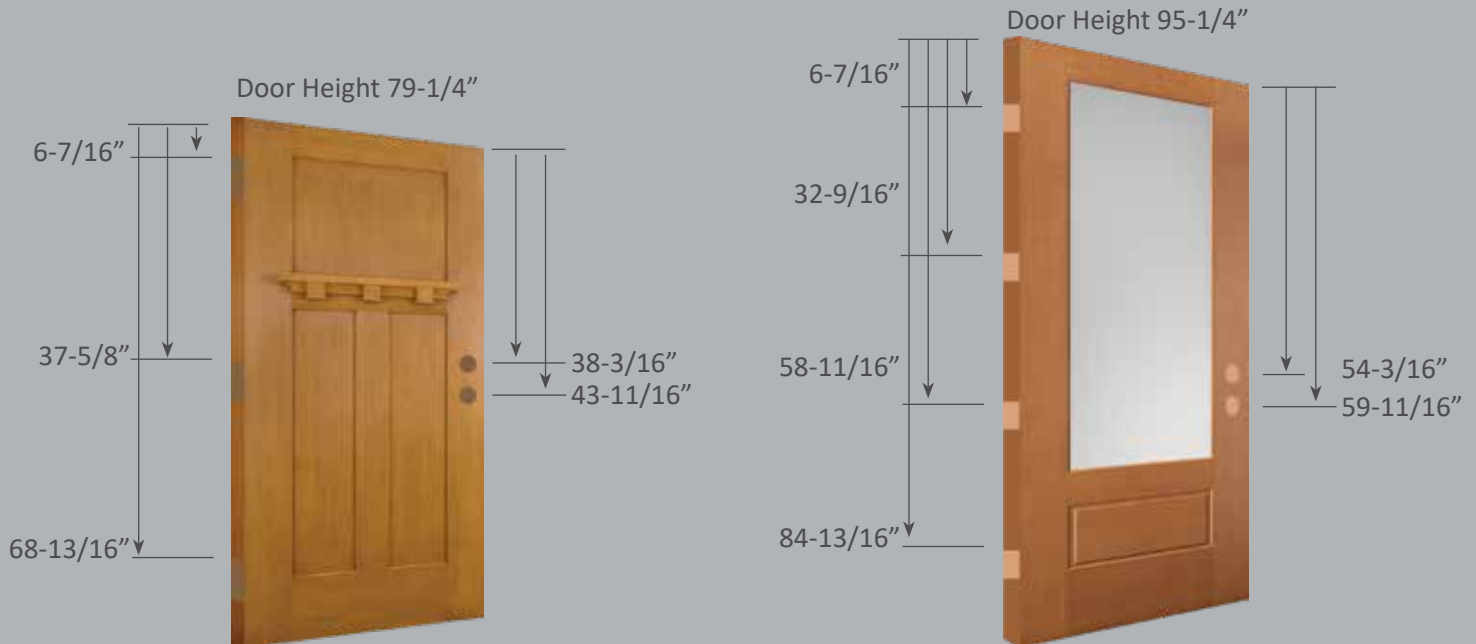

DEADBOLT PREP OPTIONS

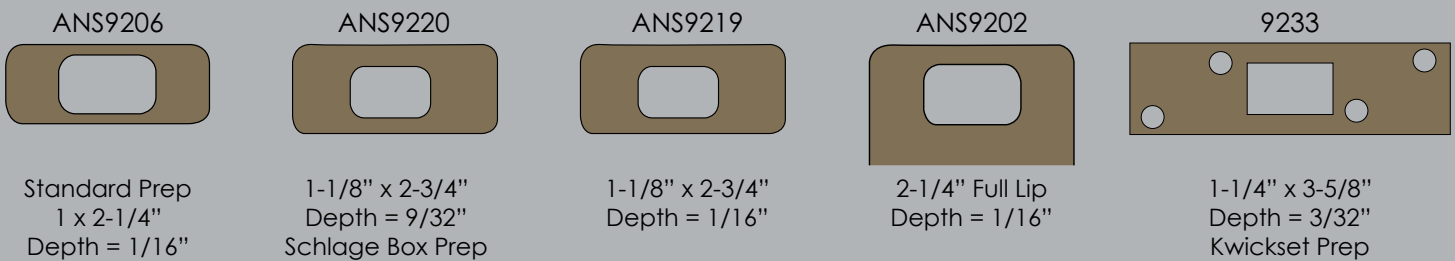



*“A very little key will open a
very heavy door!”*

—Charles Dickens

